

NOTICE:
THESE DRAWINGS AND SPECIFICATIONS AND THE IDEAS, DESIGN, AND ARRANGEMENTS REPRESENTED THEREIN ARE AND SHALL REMAIN THE PROPERTY OF BORM ASSOCIATES, INC. AND NO PART THEREOF SHALL BE COPIED, REPRODUCED, OR USED IN CONNECTION WITH ANY OTHER WORK OR PROJECT OTHER THAN THE SPECIFIC PROJECT FOR WHICH THEY HAVE BEEN PREPARED AND DEVELOPED WITHOUT THE WRITTEN CONSENT OF BORM ASSOCIATES, INC. ANY CONTACT WITH THESE DRAWINGS OR SPECIFICATIONS SHALL CONSTITUTE CONCLUSIVE EVIDENCE OF THESE RESTRICTIONS.

WRITTEN DIMENSIONS ON THESE DRAWINGS SHALL HAVE PRECEDENCE OVER SCALED DIMENSIONS. CONTRACTORS SHALL VERIFY, AND BE RESPONSIBLE FOR ALL DIMENSIONS AND CONDITIONS ON THE JOB. THIS OFFICE MUST BE NOTIFIED OF VARIATIONS FROM THE DIMENSIONS AND CONDITIONS SHOWN BY THESE DRAWINGS.

REFER TO 5N SHEETS FOR ALL NOTES AND SPECIFICATIONS
PROJECT:
Broadway at San Marcos

OWNER/DEVELOPER:
Liberty Homes

ARCHITECT/DESIGNER:
MDW Designs

SHEET:
AZ-NV

STRUCTURAL OPEN WEB FLOOR TRUSS DETAILS (1 thru 30)

REFERENCE DATE: 03-28-07
ISSUED FOR: CLIENT DELIVERY 03-29-07

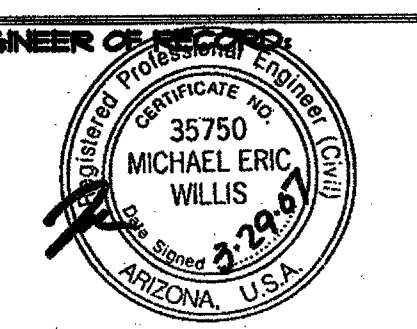
ENGINEER OF RECORD:

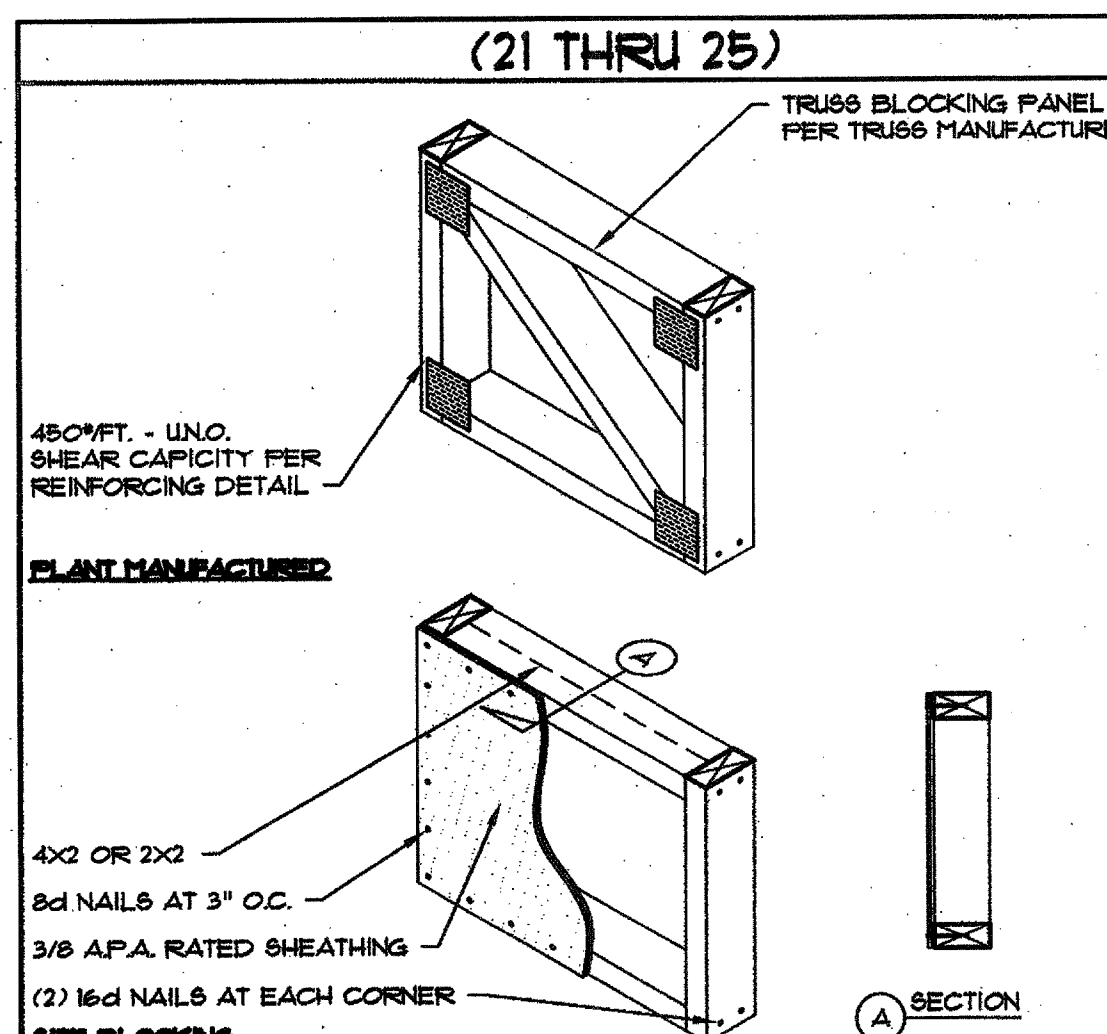
CONTACTS:
-For design questions regarding these plans and specifications contact the Project Manager:
Steve Danner
Telephone: (623) 869-0601 ext. 233
Facsimile: (623) 869-0609
Email: steved@borm.com
-For scheduling site observation and for field changes contact the Construction Administrator:
Alissa Engle
Telephone: (623) 869-0601 ext. 232
Facsimile: (623) 869-0609
Email: alissa@borm.com
FILE NO: 12664
CAD NO: 12664 8D5-0
DRAWN BY: KER
ENGINEER: MH
SCALE: 1/8" = 1'-0"
SHT NO: **8D5.0**

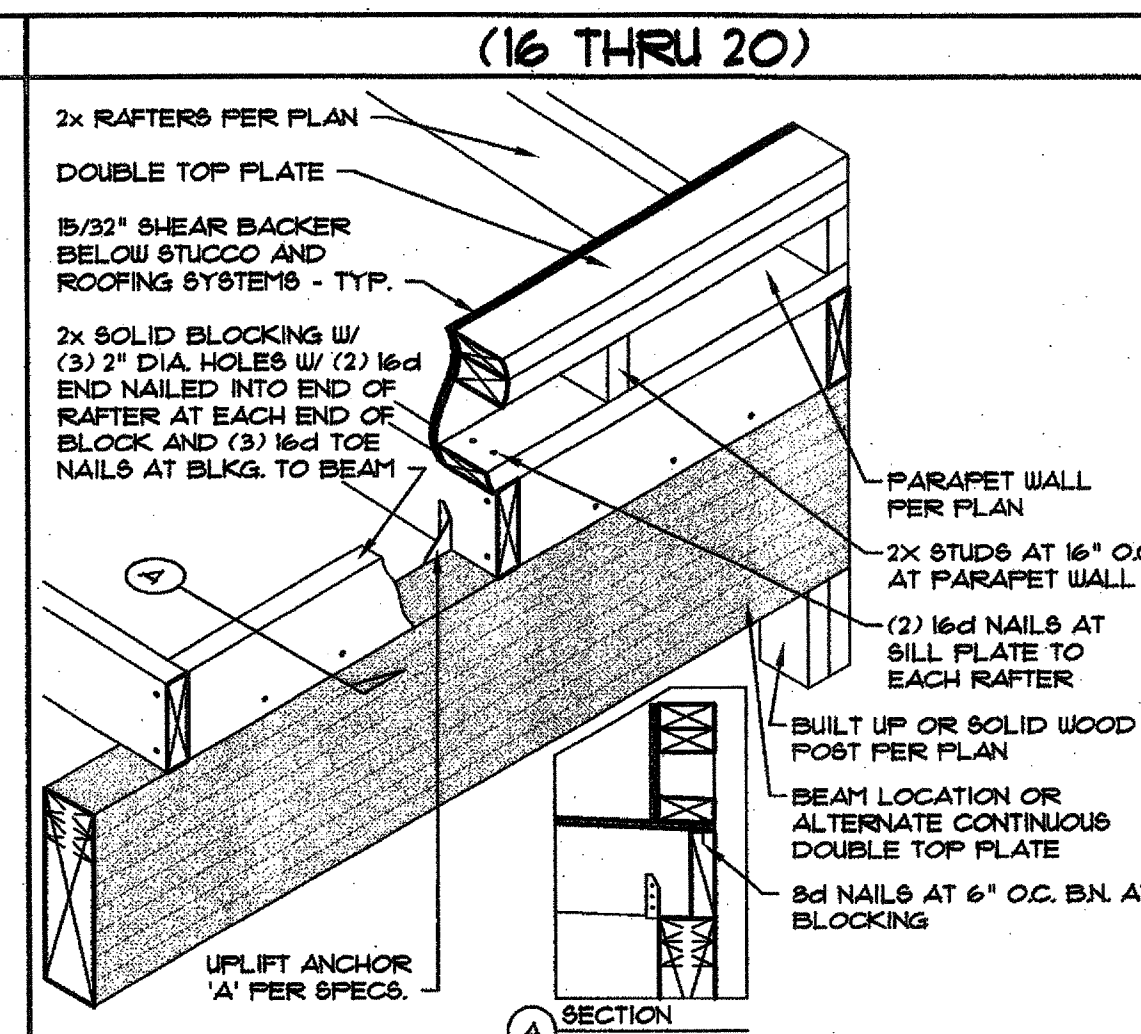

21 BLOCKING PANEL SCALE: 1" = 1'-0" © 8D5-05-04 BAI BAI NO.: 107698AZ

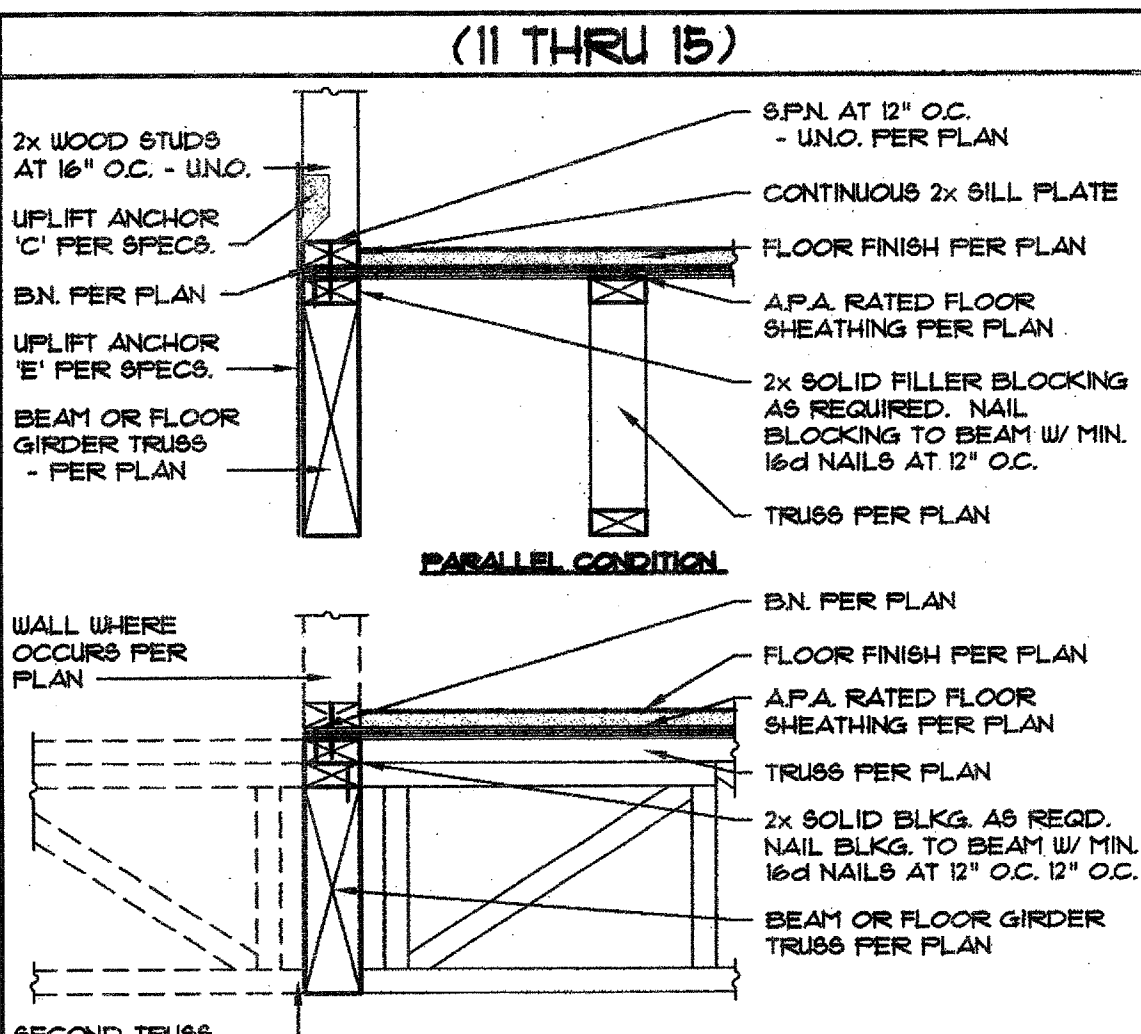

16 CONNECTION RAFTER TO BEAM AT WALK DECK SCALE: 1" = 1'-0" © 8D5-05-04 BAI BAI NO.: 107698AZ



11 CONNECTION AT FLUSH BRAM/HANGER SCALE: 1" = 1'-0" © 8D5-05-04 BAI BAI NO.: 107698AZ

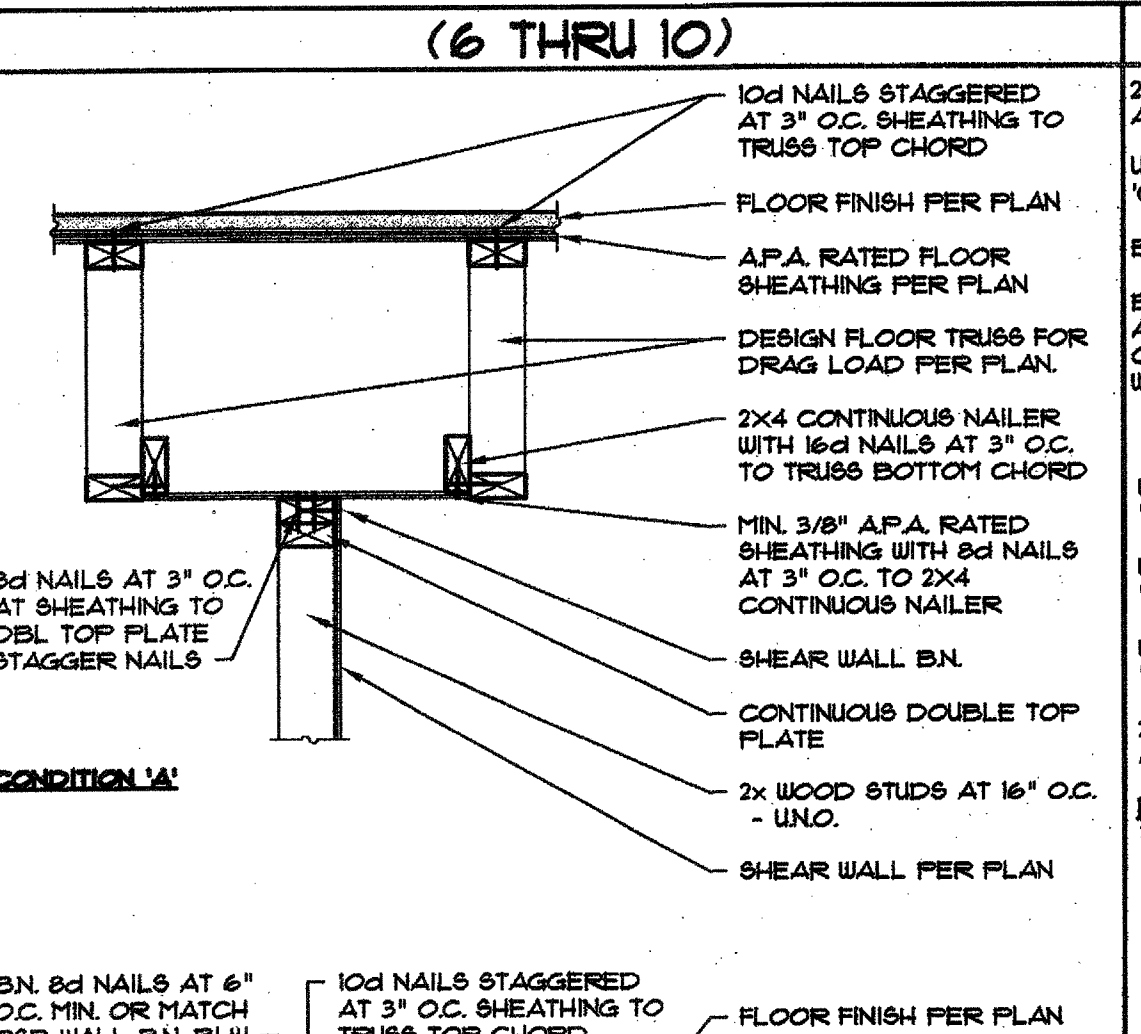

6 SHEAR WALLS AT LOWER SHEAR WALL SCALE: 1" = 1'-0" © 8D5-05-04 BAI BAI NO.: 107698AZ

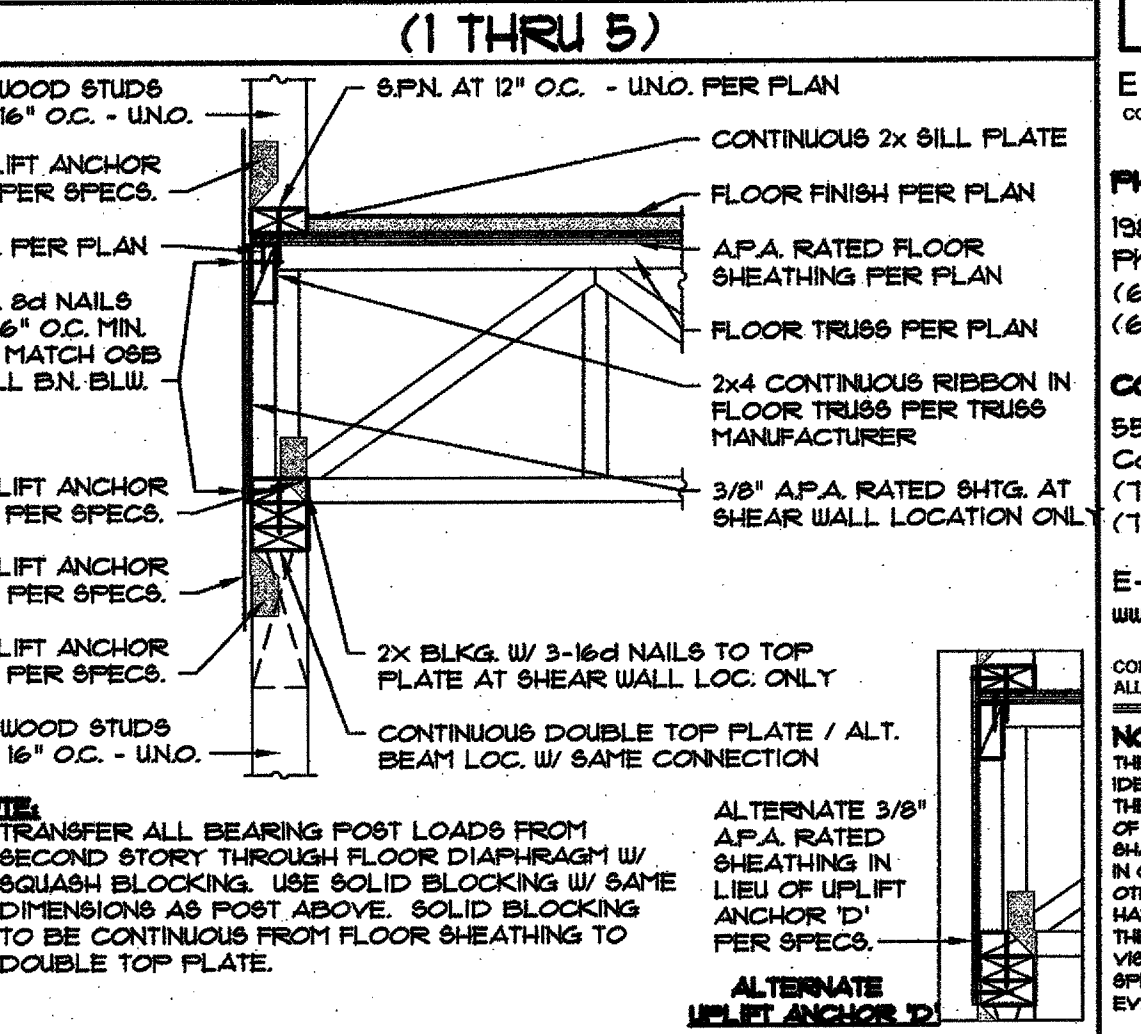

1 RIM AT EXTERIOR WALL PERPENDICULAR SCALE: 1" = 1'-0" © 8D5-05-04 BAI BAI NO.: 107698AZ

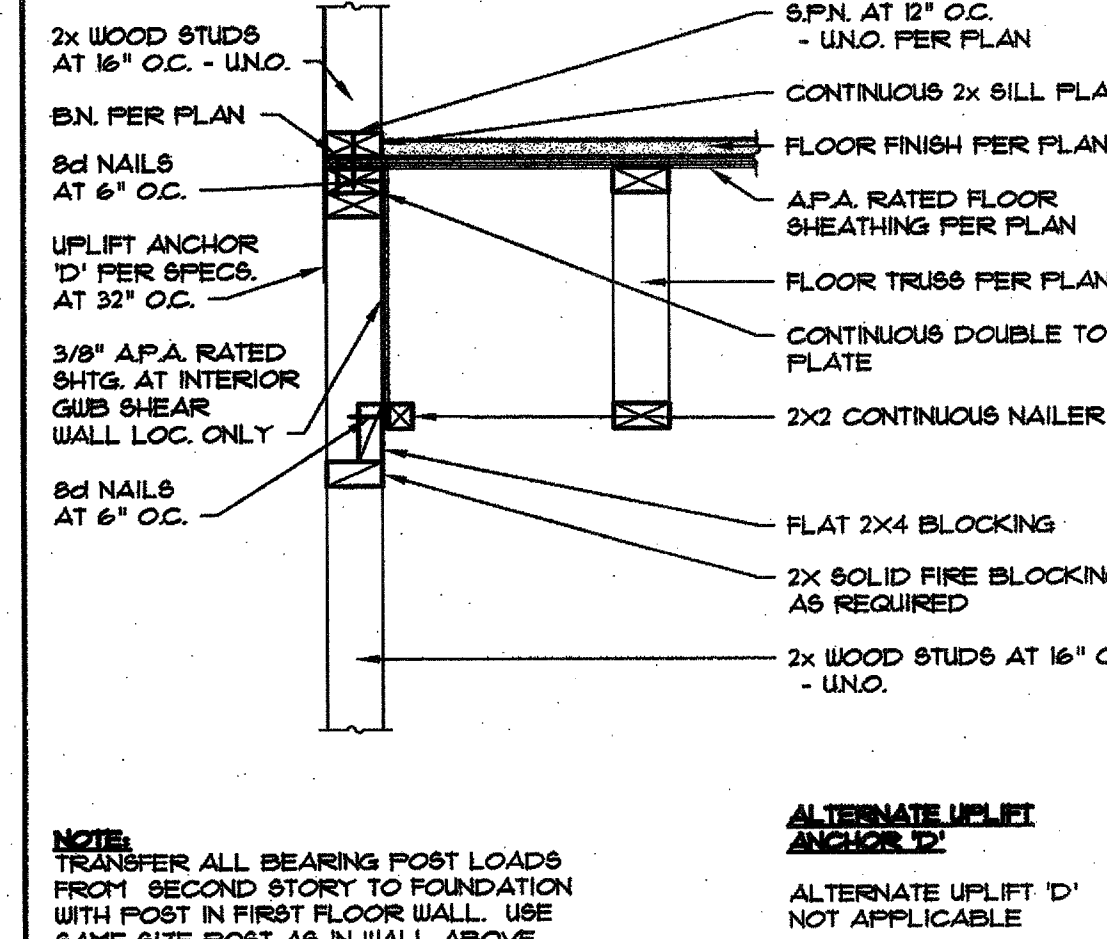

22 FLOOR TRUSS AT EXTERIOR WALL PARALLEL SCALE: 1" = 1'-0" © 8D5-05-04 BAI BAI NO.: 107698AZ

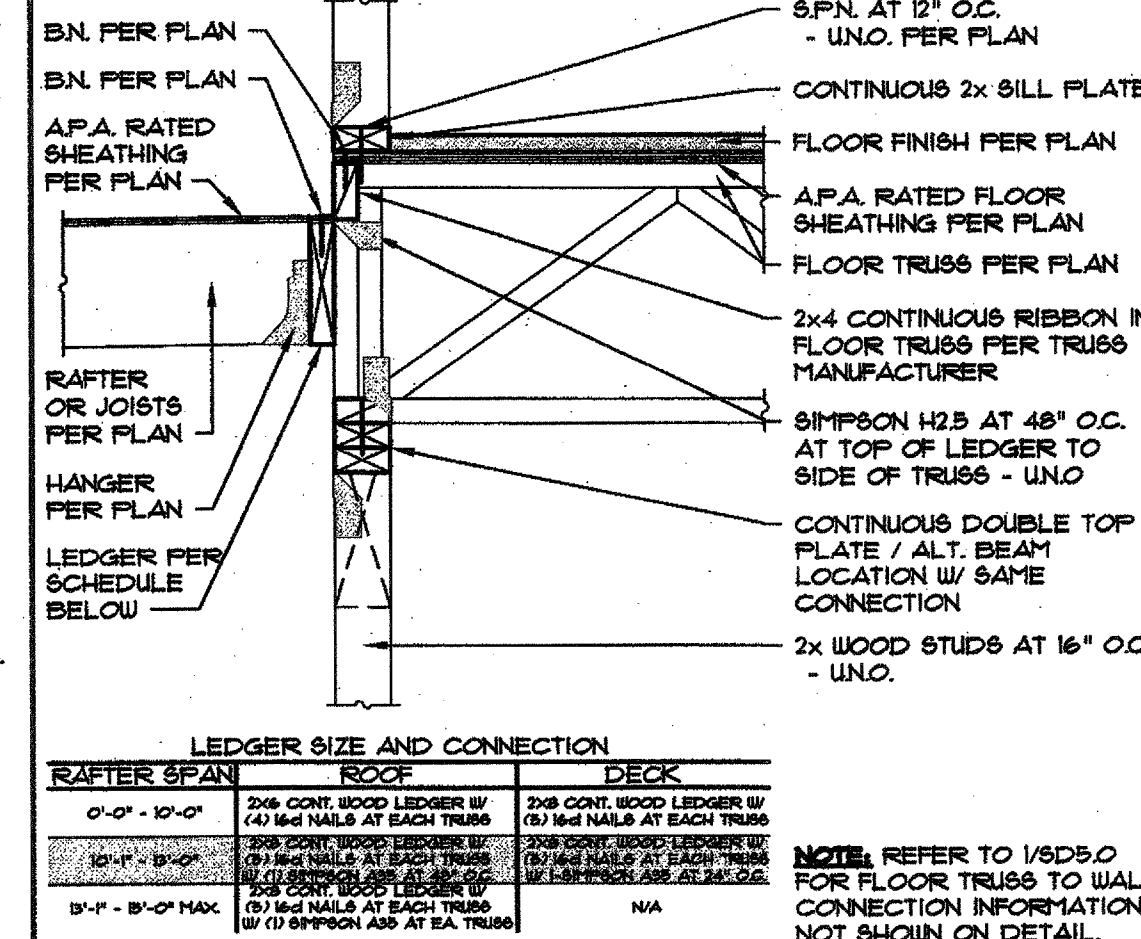

17 FLOOR TRUSS AT LEDGER AT PERP. RAFTER SCALE: 1" = 1'-0" © 8D5-05-04 BAI BAI NO.: 107698AZ

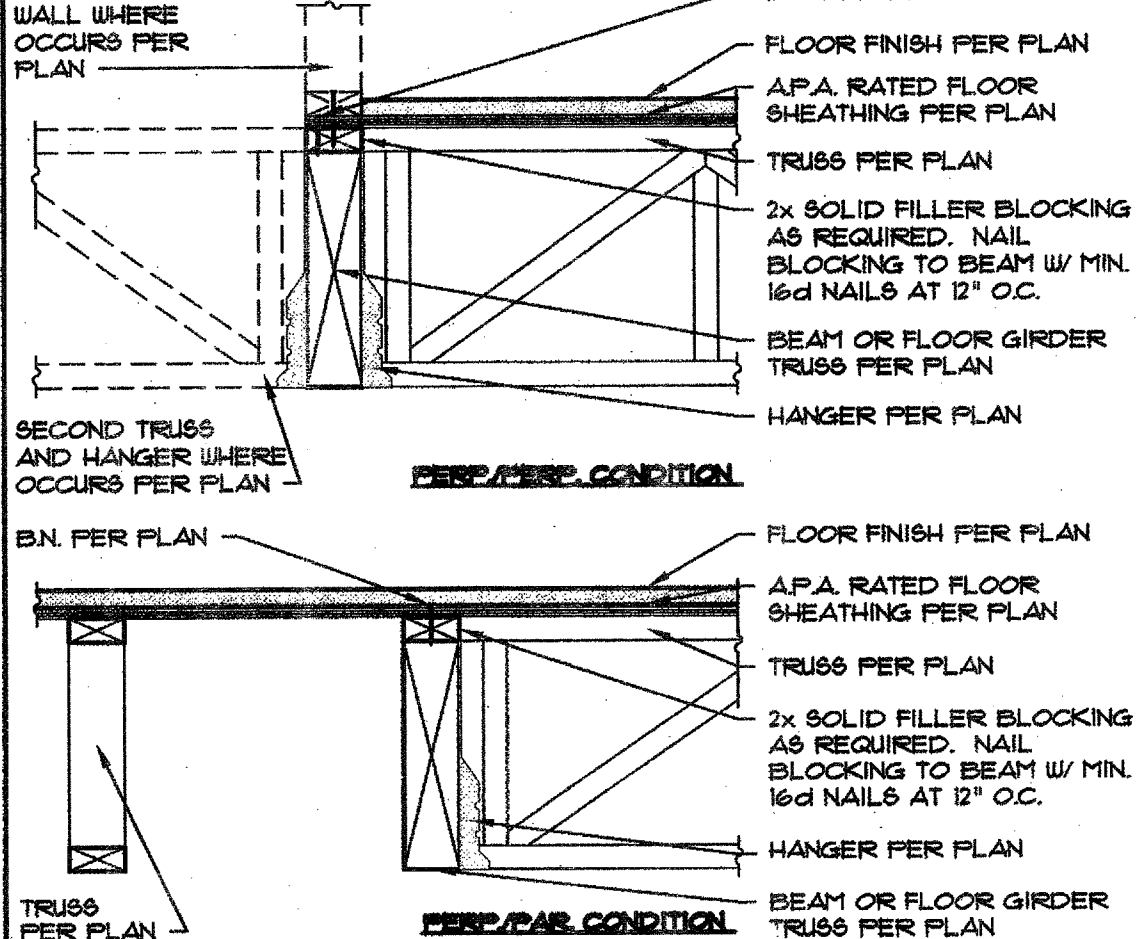

11 CONNECTION AT FLUSH BRAM/HANGER SCALE: 1" = 1'-0" © 8D5-05-04 BAI BAI NO.: 107698AZ

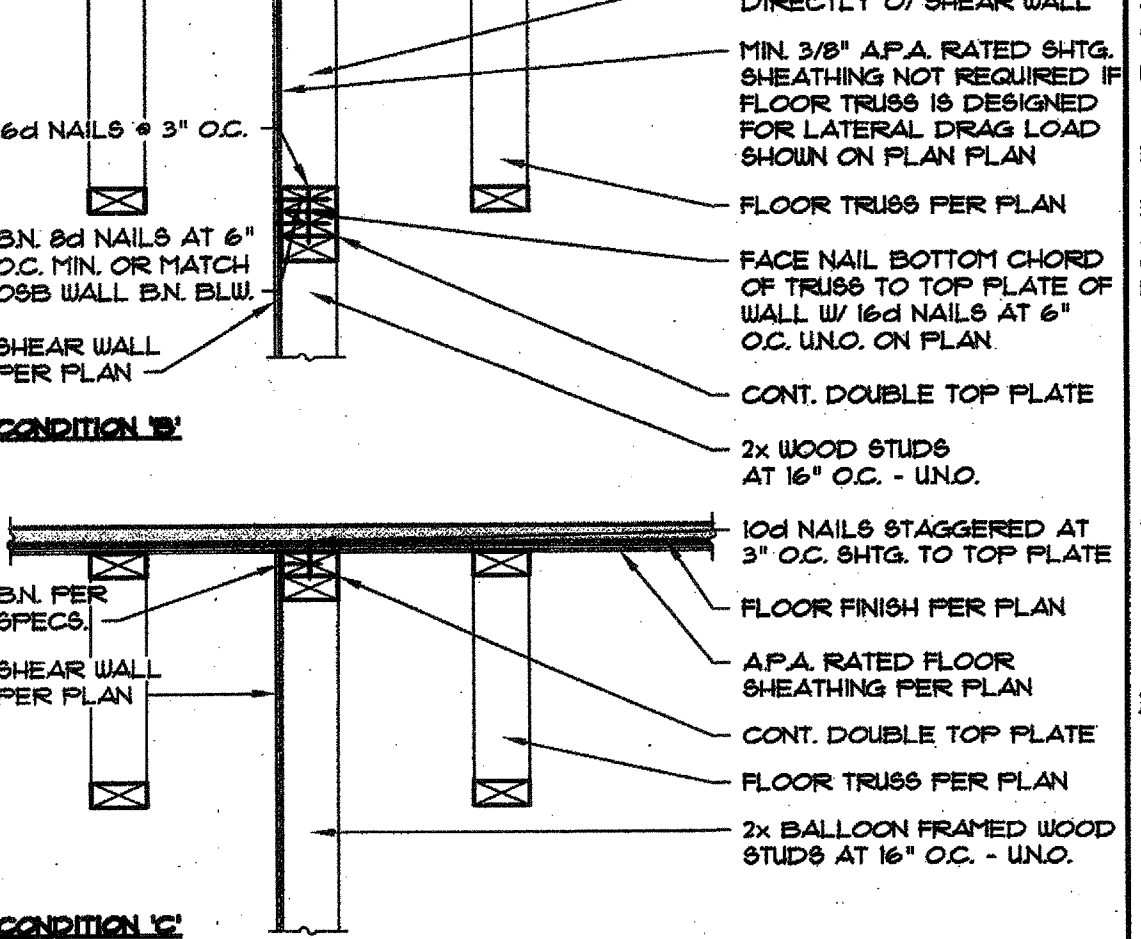

6 SHEAR WALLS AT LOWER SHEAR WALL SCALE: 1" = 1'-0" © 8D5-05-04 BAI BAI NO.: 107698AZ

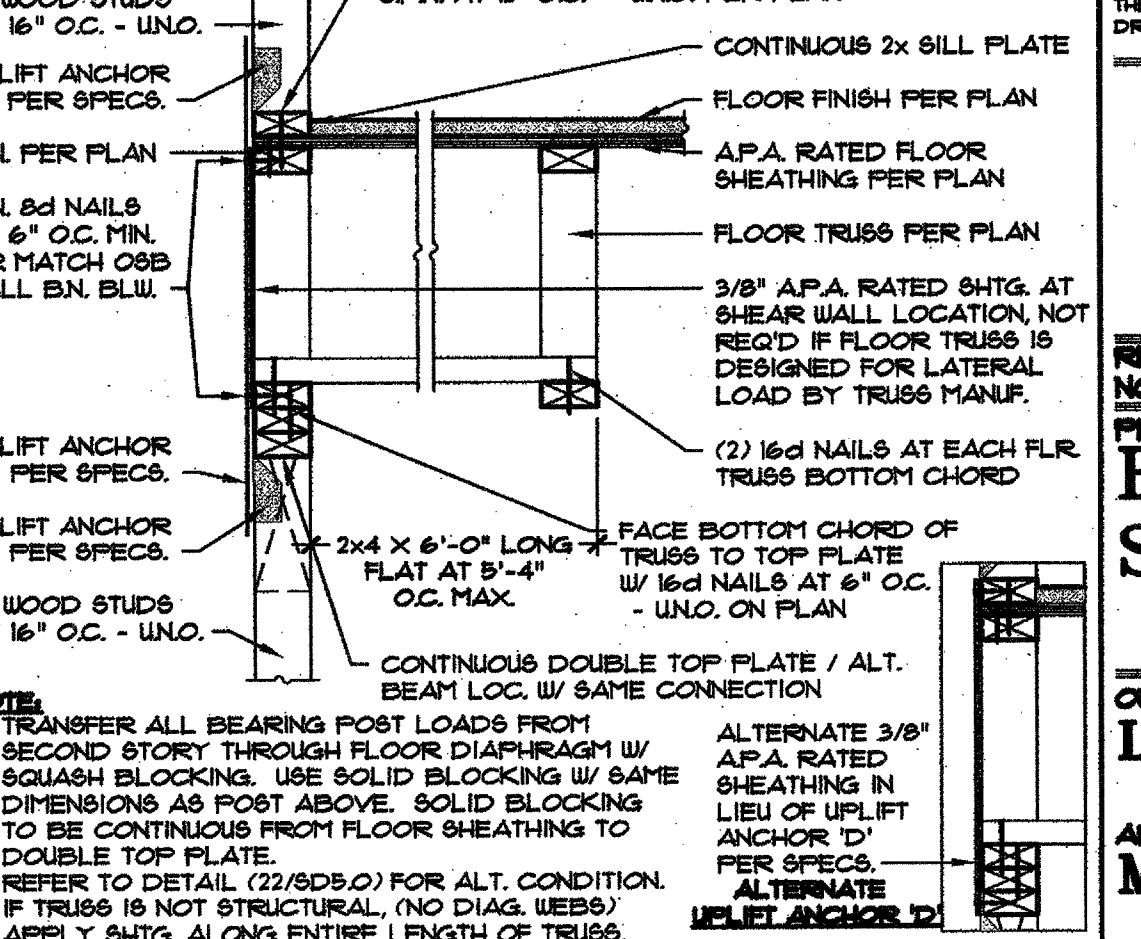

2 RIM AT EXTERIOR WALL PARALLEL SCALE: 1" = 1'-0" © 8D5-05-04 BAI BAI NO.: 107698AZ

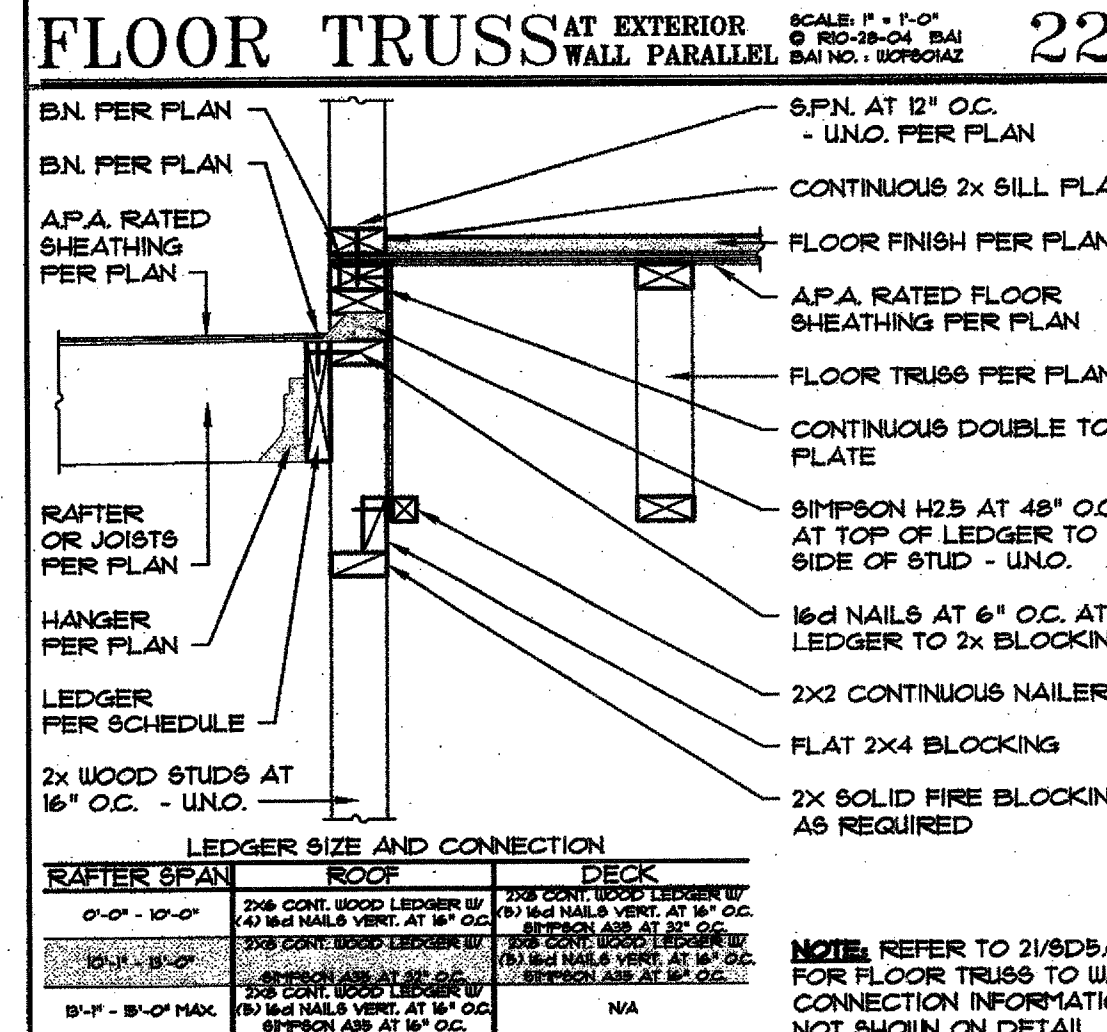

23 FLOOR TRUSS AT LEDGER AT PERP. RAFTER SCALE: 1" = 1'-0" © 8D5-05-04 BAI BAI NO.: 107698AZ

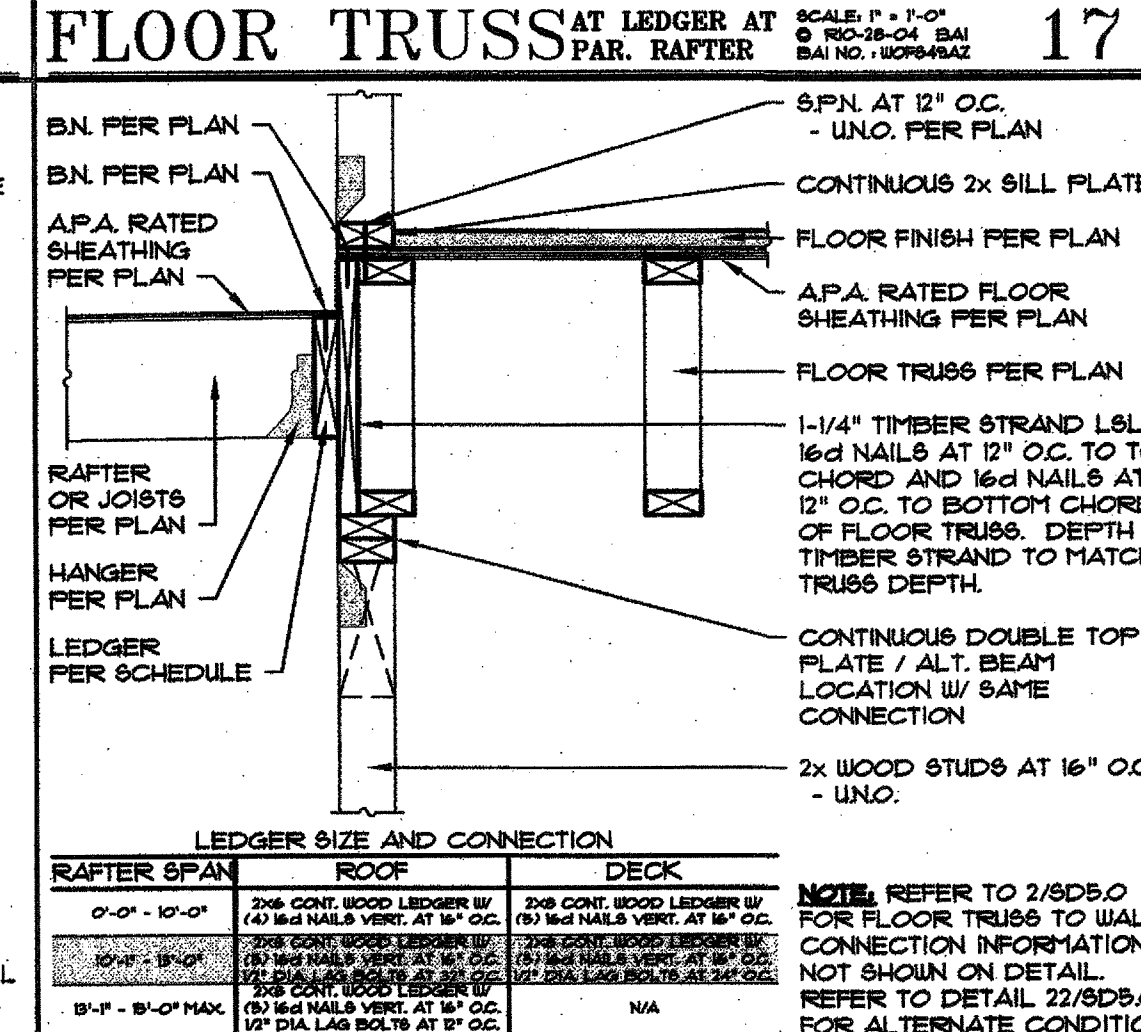

18 FLOOR TRUSS AT LEDGER AT PERP. RAFTER SCALE: 1" = 1'-0" © 8D5-05-04 BAI BAI NO.: 107698AZ

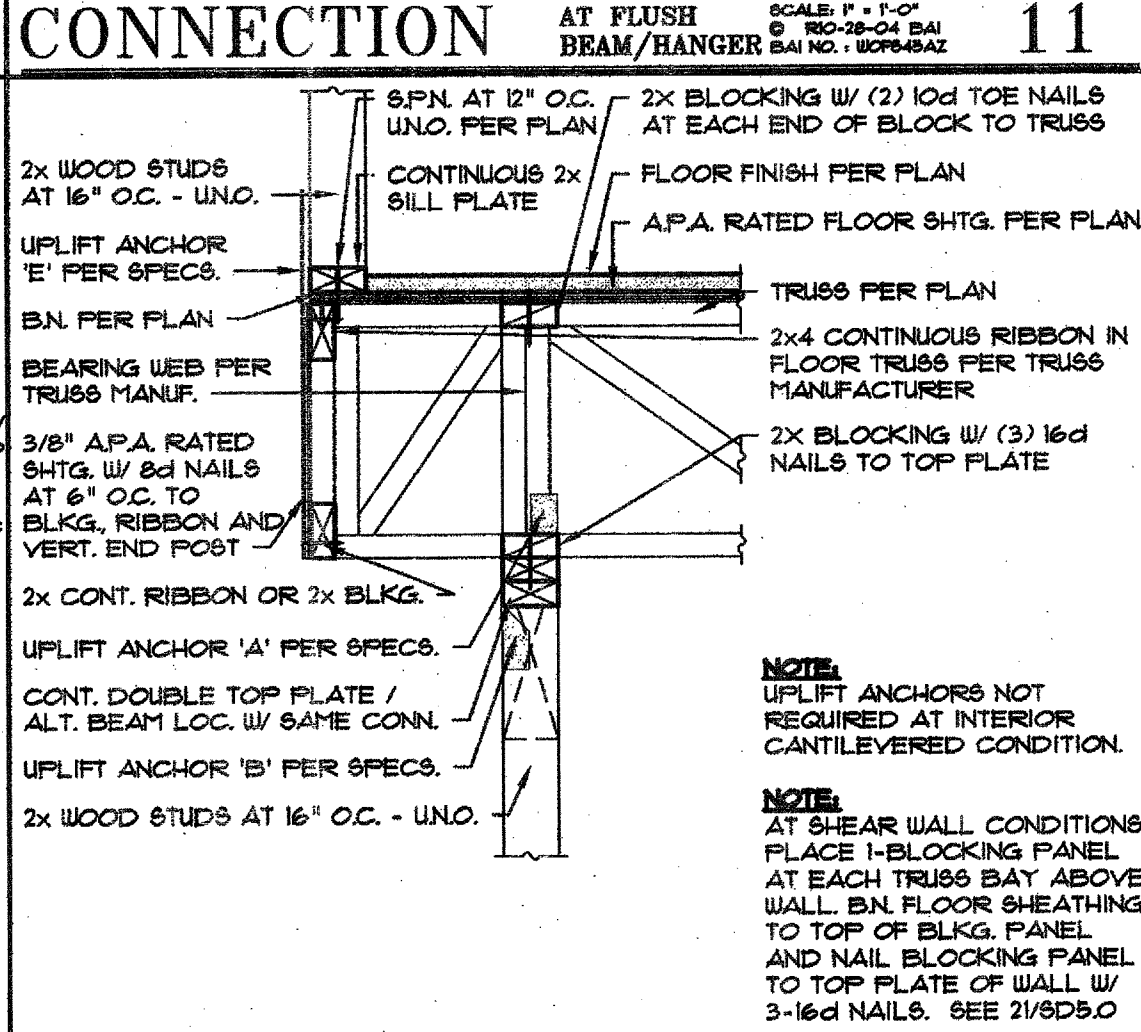

12 CANT. SUPPORT AT EXT. WALL SCALE: 1" = 1'-0" © 8D5-05-04 BAI BAI NO.: 107698AZ

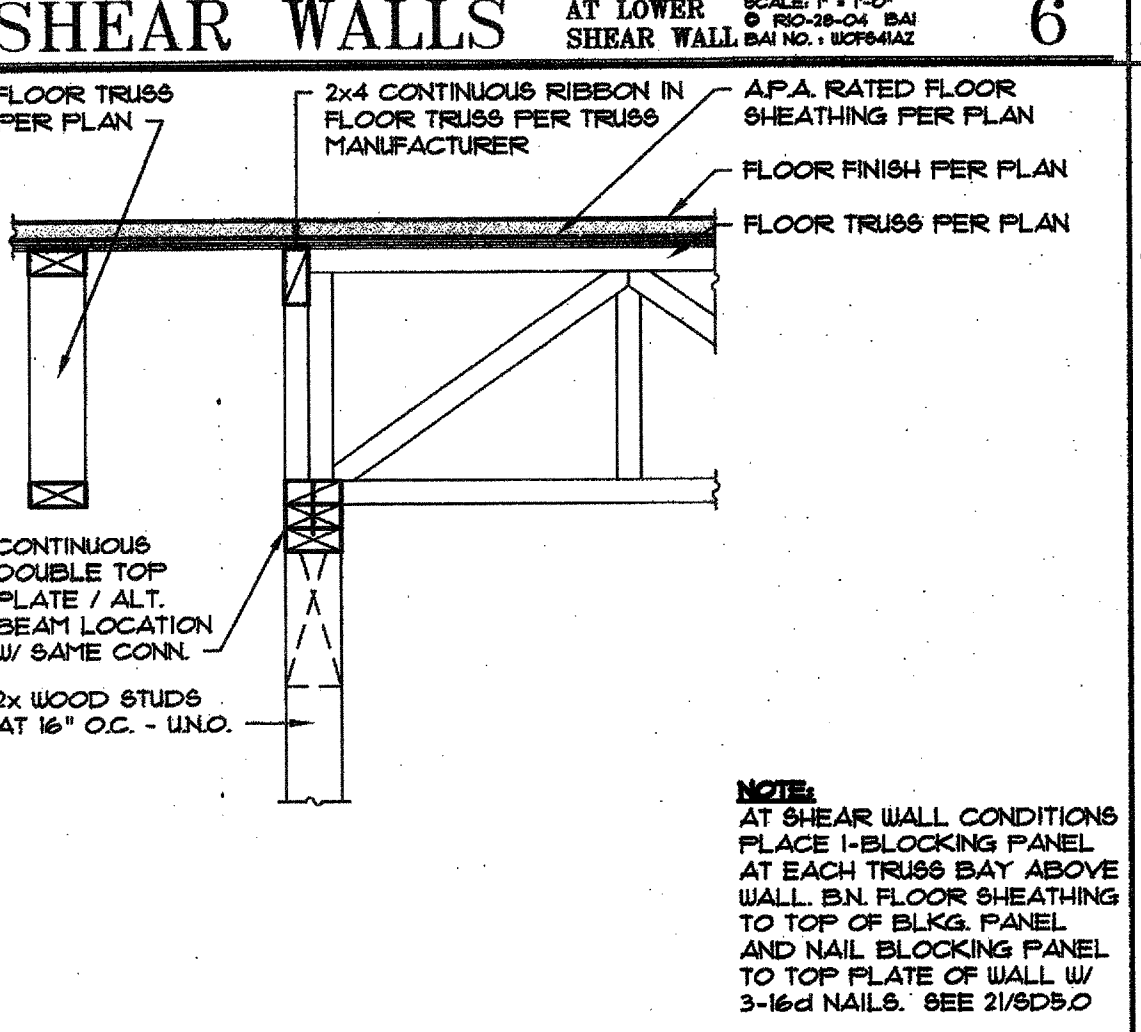

7 INT. SUPPORT PERP. TO WALL SCALE: 1" = 1'-0" © 8D5-05-04 BAI BAI NO.: 107698AZ

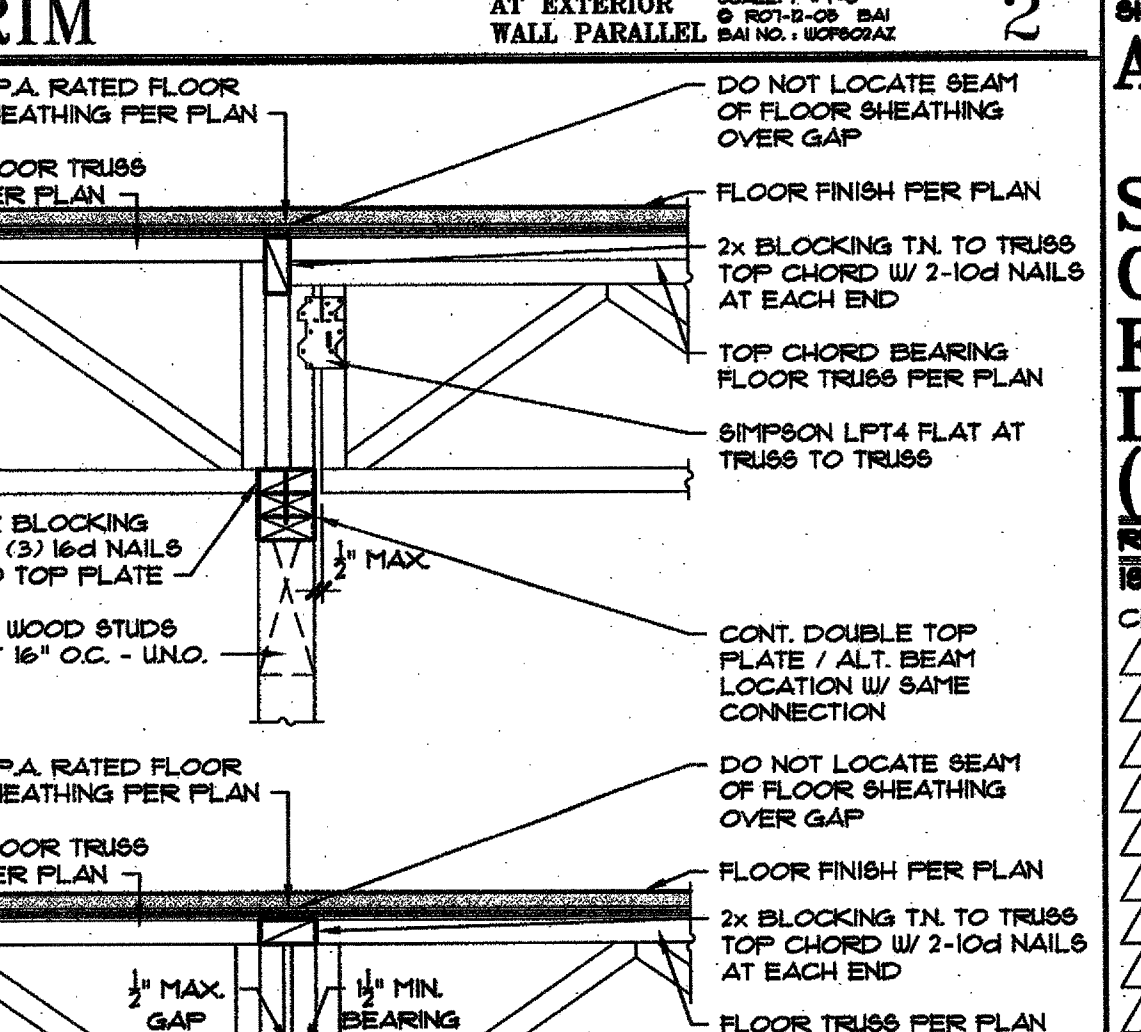

3 INT. SUPPORT PERP. TO WALL SCALE: 1" = 1'-0" © 8D5-05-04 BAI BAI NO.: 107698AZ

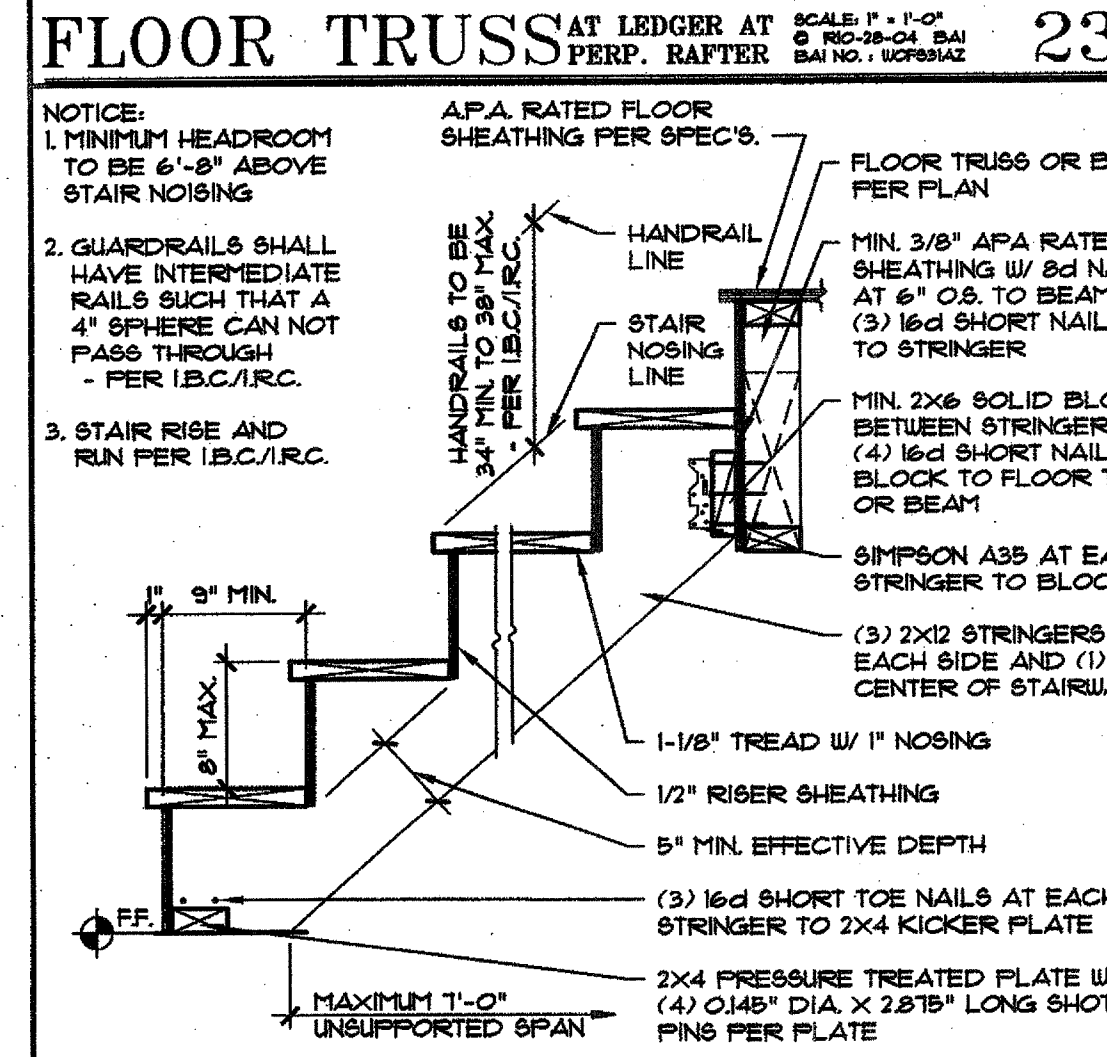

19 STAIR AND LANDING SCALE: 1" = 1'-0" © 8D5-05-04 BAI BAI NO.: 107698AZ

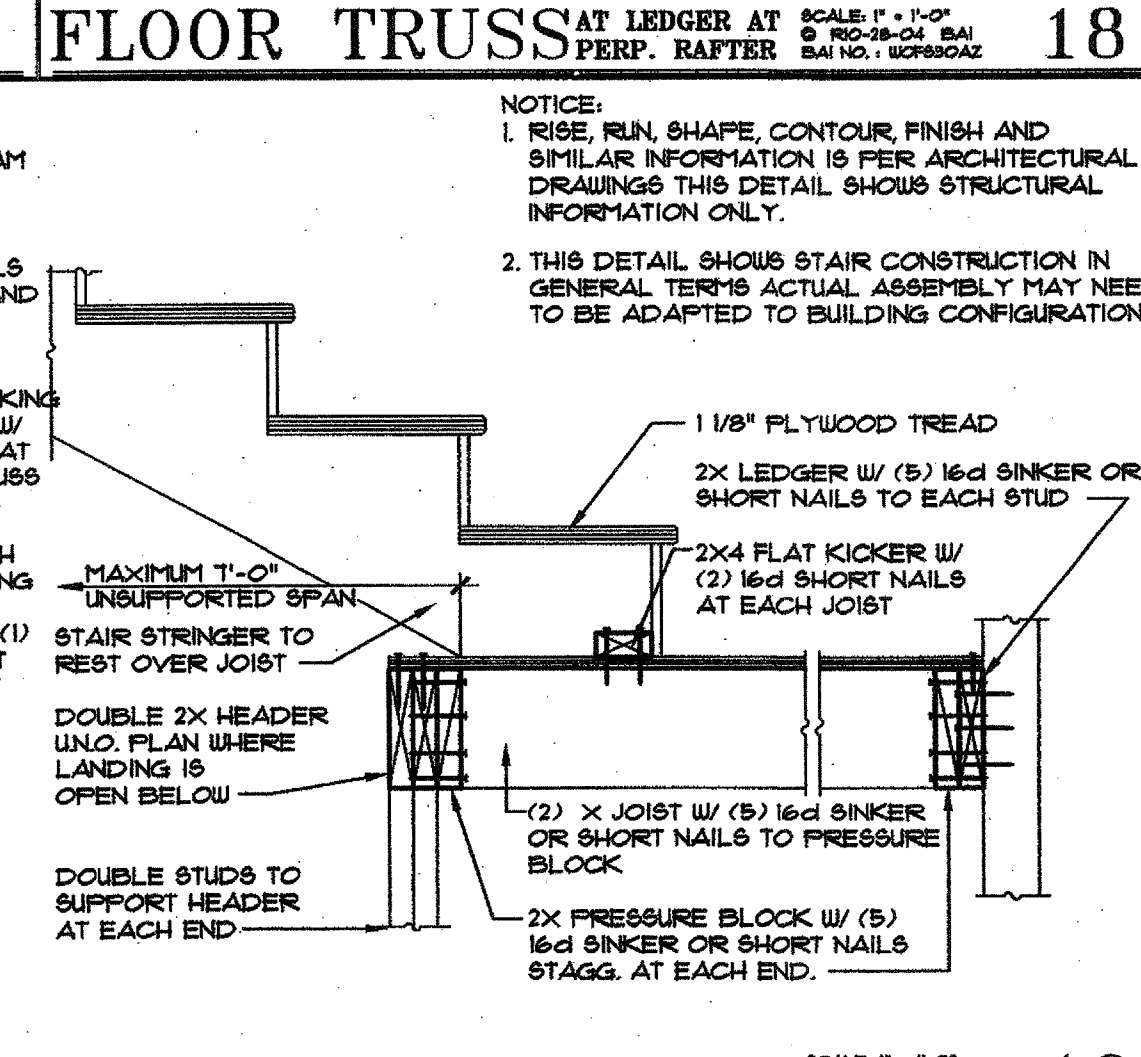

19 STAIR AND LANDING SCALE: 1" = 1'-0" © 8D5-05-04 BAI BAI NO.: 107698AZ

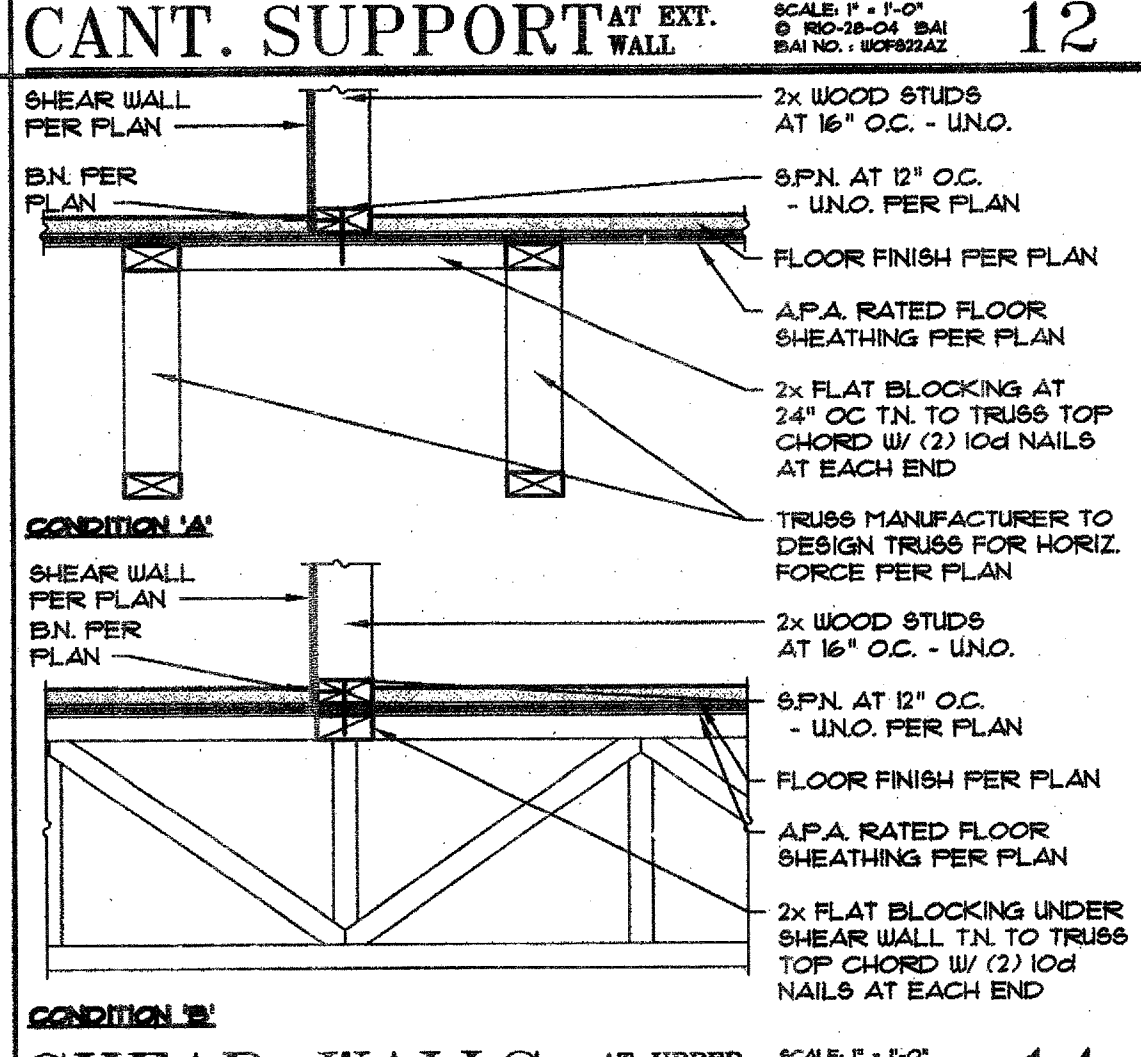

14 SHEAR WALLS AT UPPER SHEAR WALL SCALE: 1" = 1'-0" © 8D5-05-04 BAI BAI NO.: 107698AZ

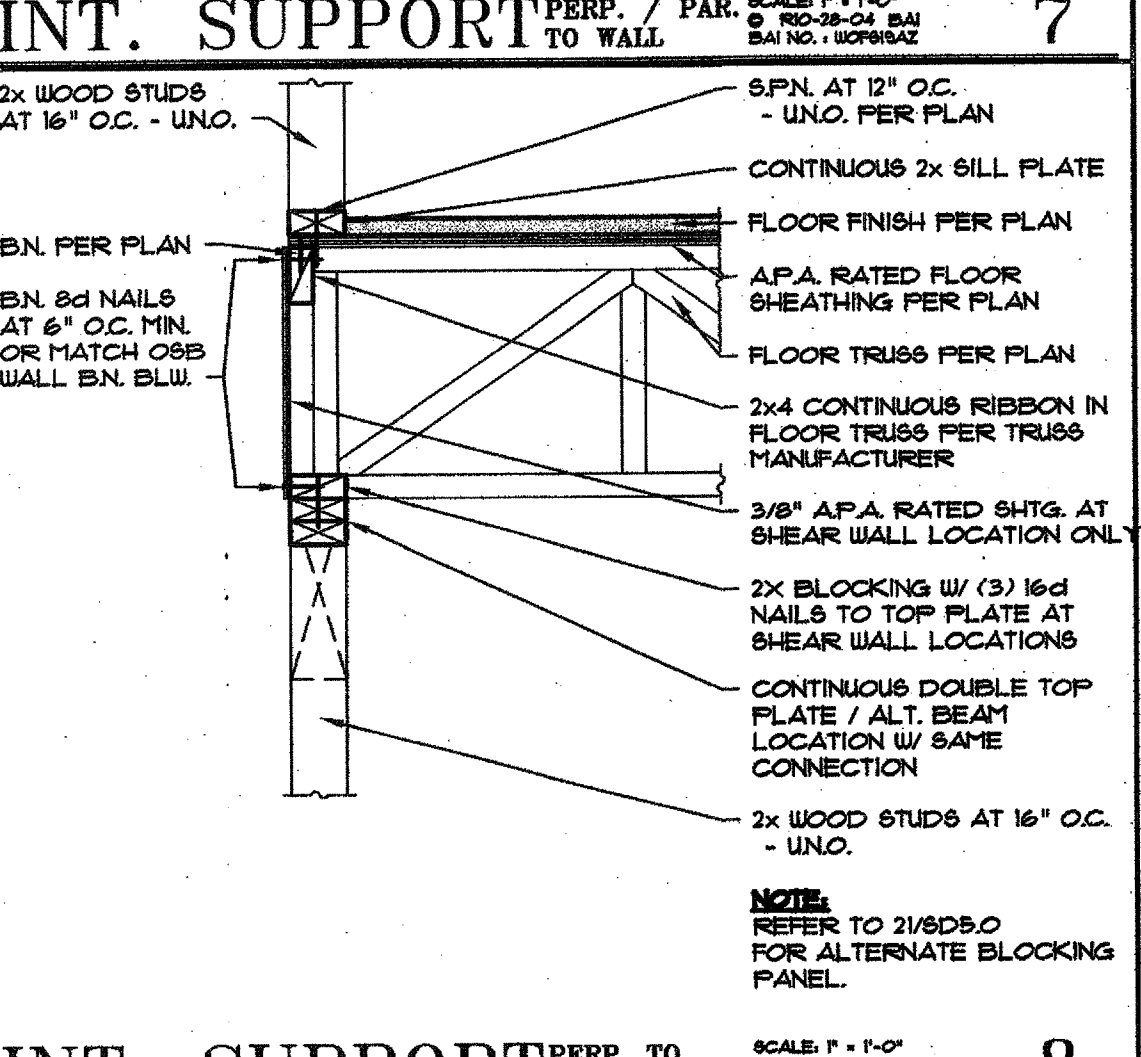

8 INT. SUPPORT PERP. TO WALL SCALE: 1" = 1'-0" © 8D5-05-04 BAI BAI NO.: 107698AZ

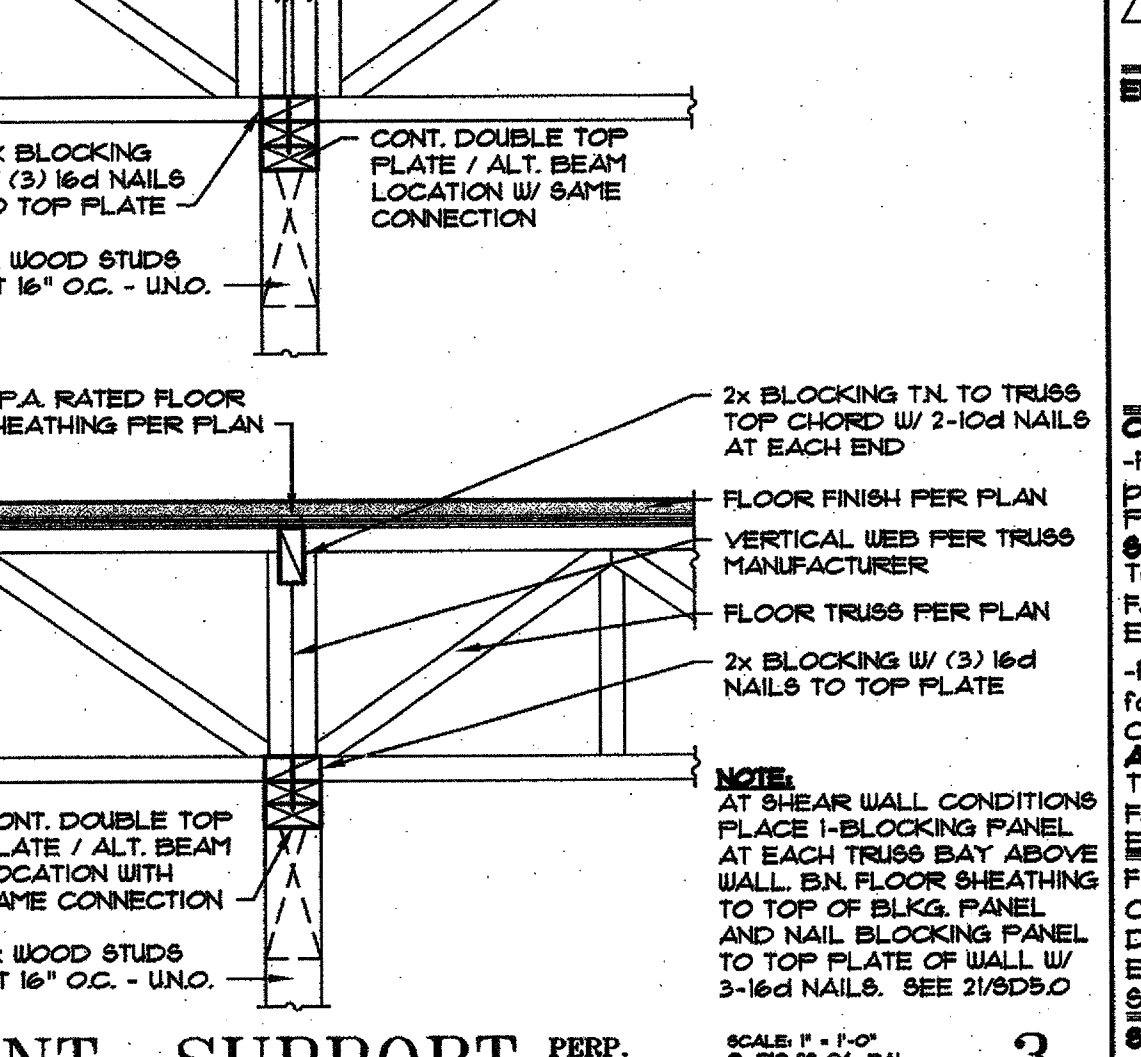

3 INT. SUPPORT PERP. TO WALL SCALE: 1" = 1'-0" © 8D5-05-04 BAI BAI NO.: 107698AZ